



Why is he scared ?



What's the man banging?



What's Mickey playing?

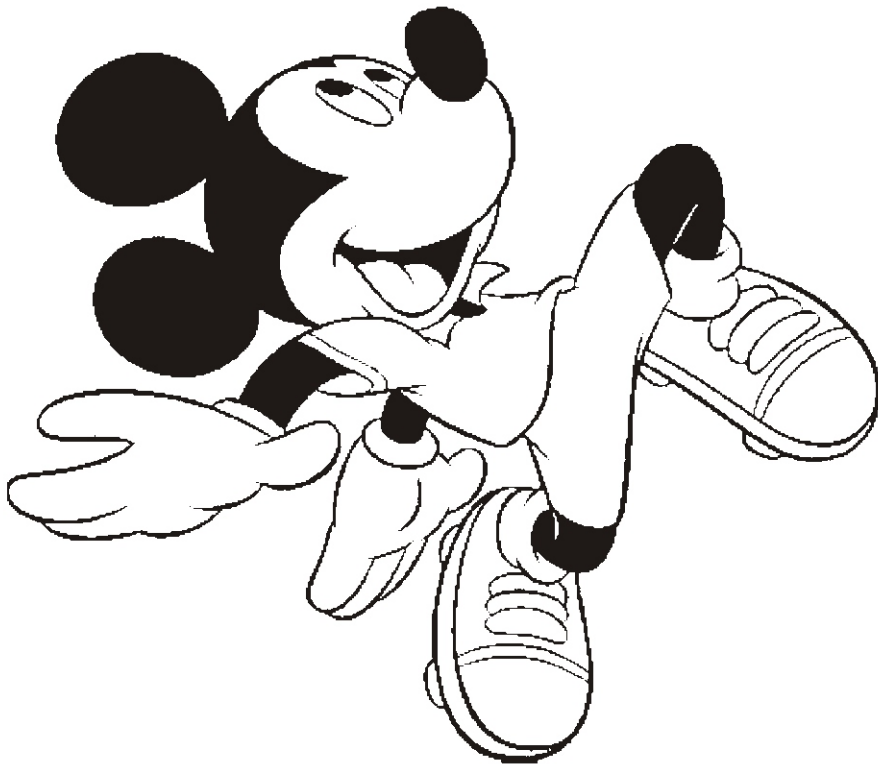

# Build a house

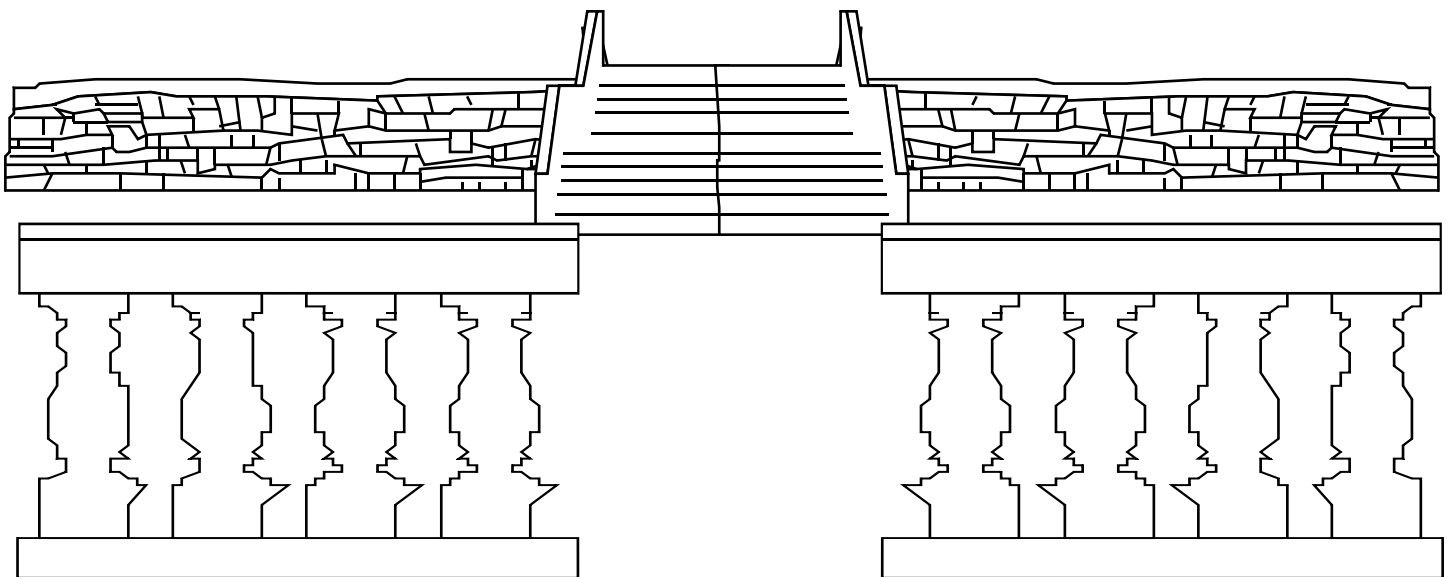

Which ones are slugs and which ones are snails ?

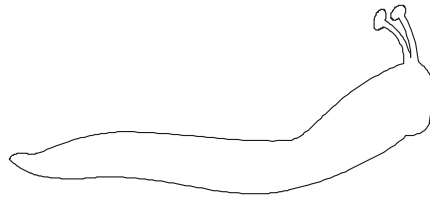
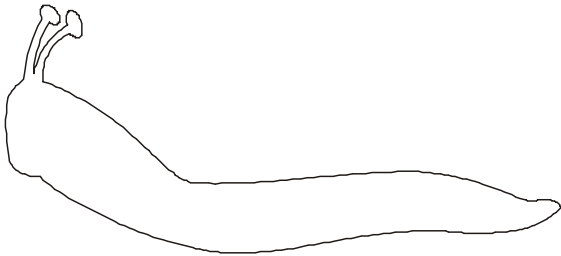
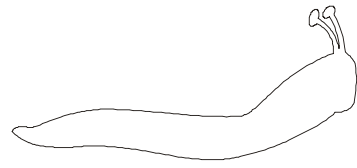
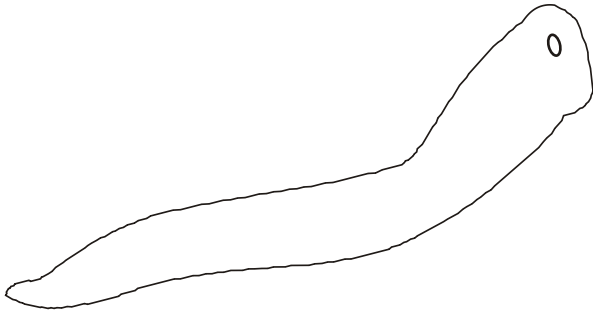

What's in the web ?

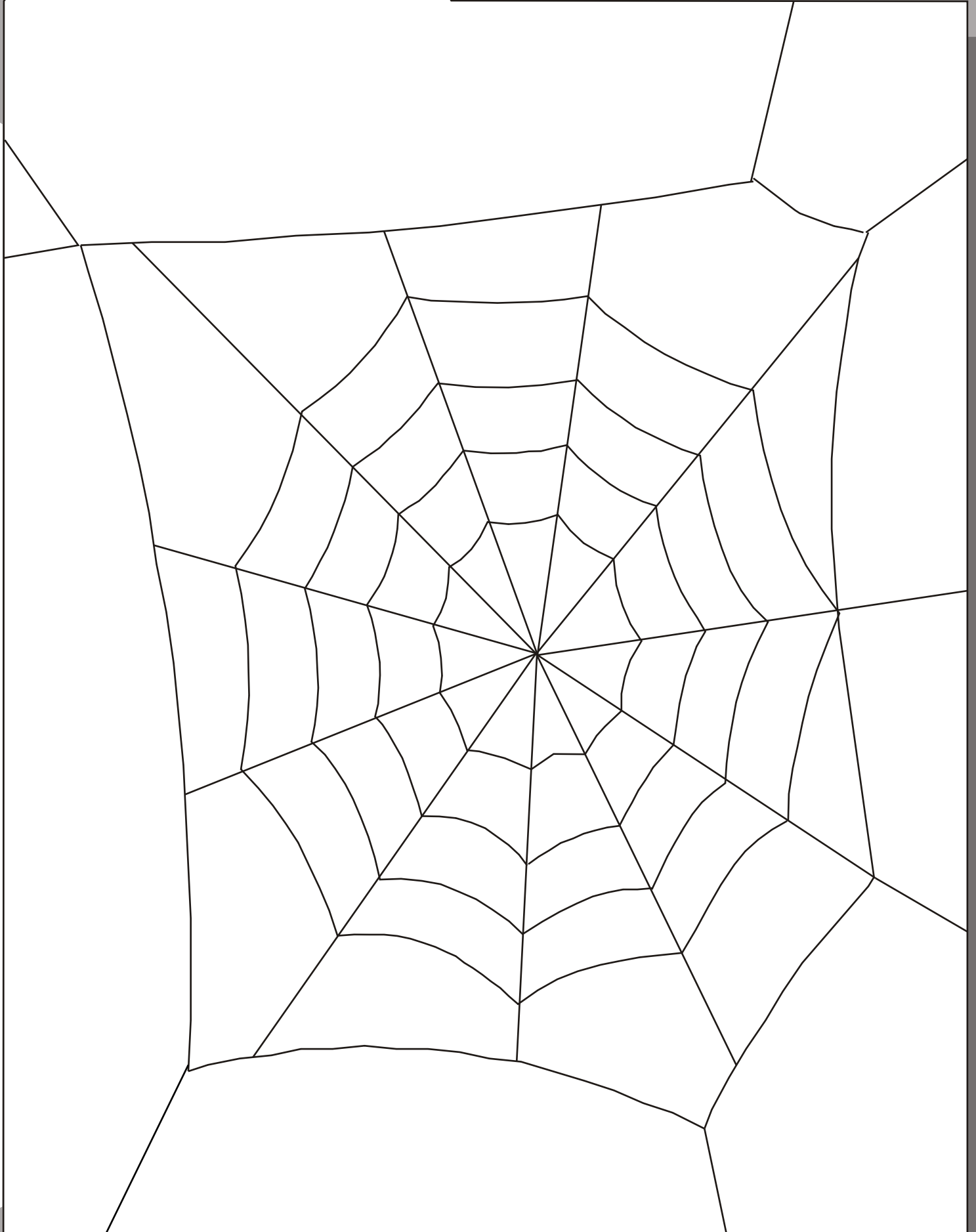

Beware of the sea monster !

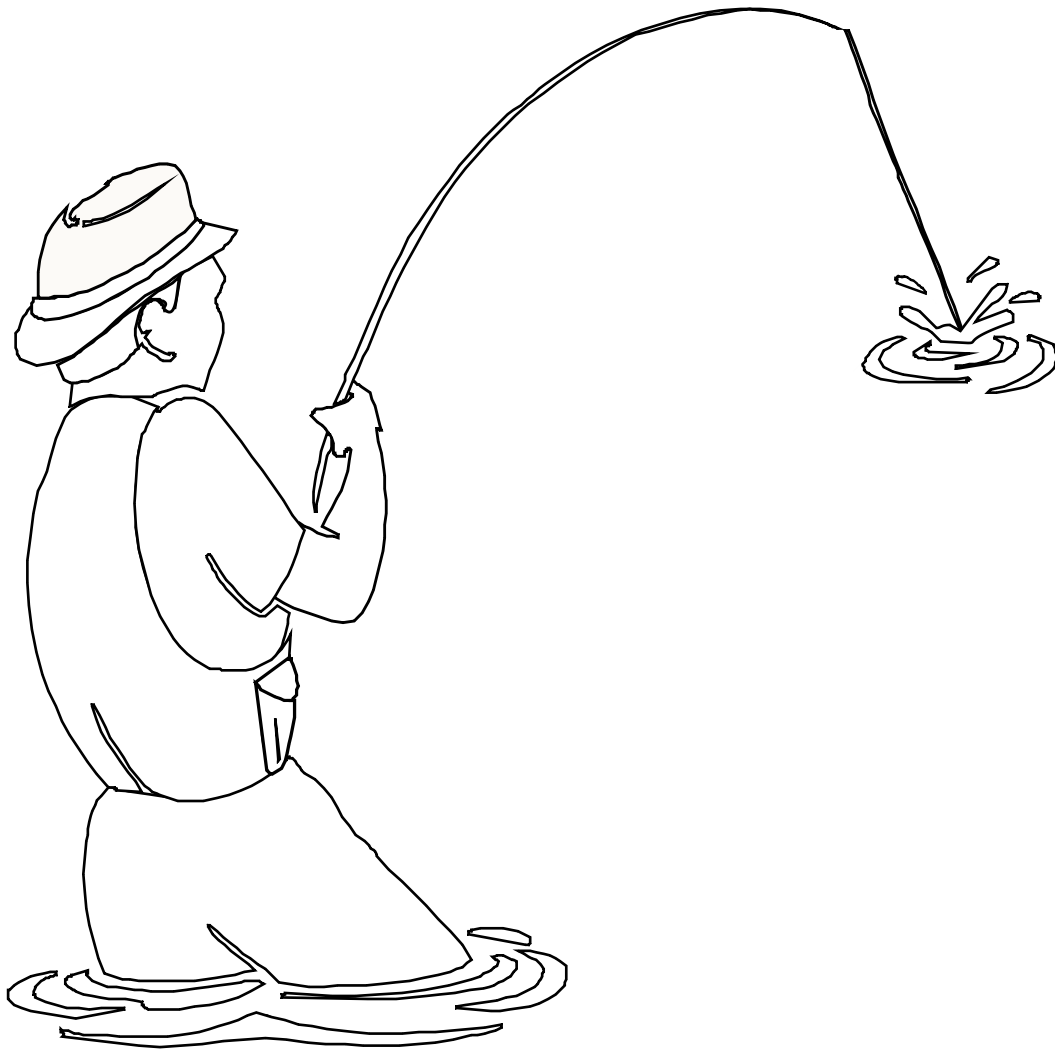



Create a crazy hairstyle

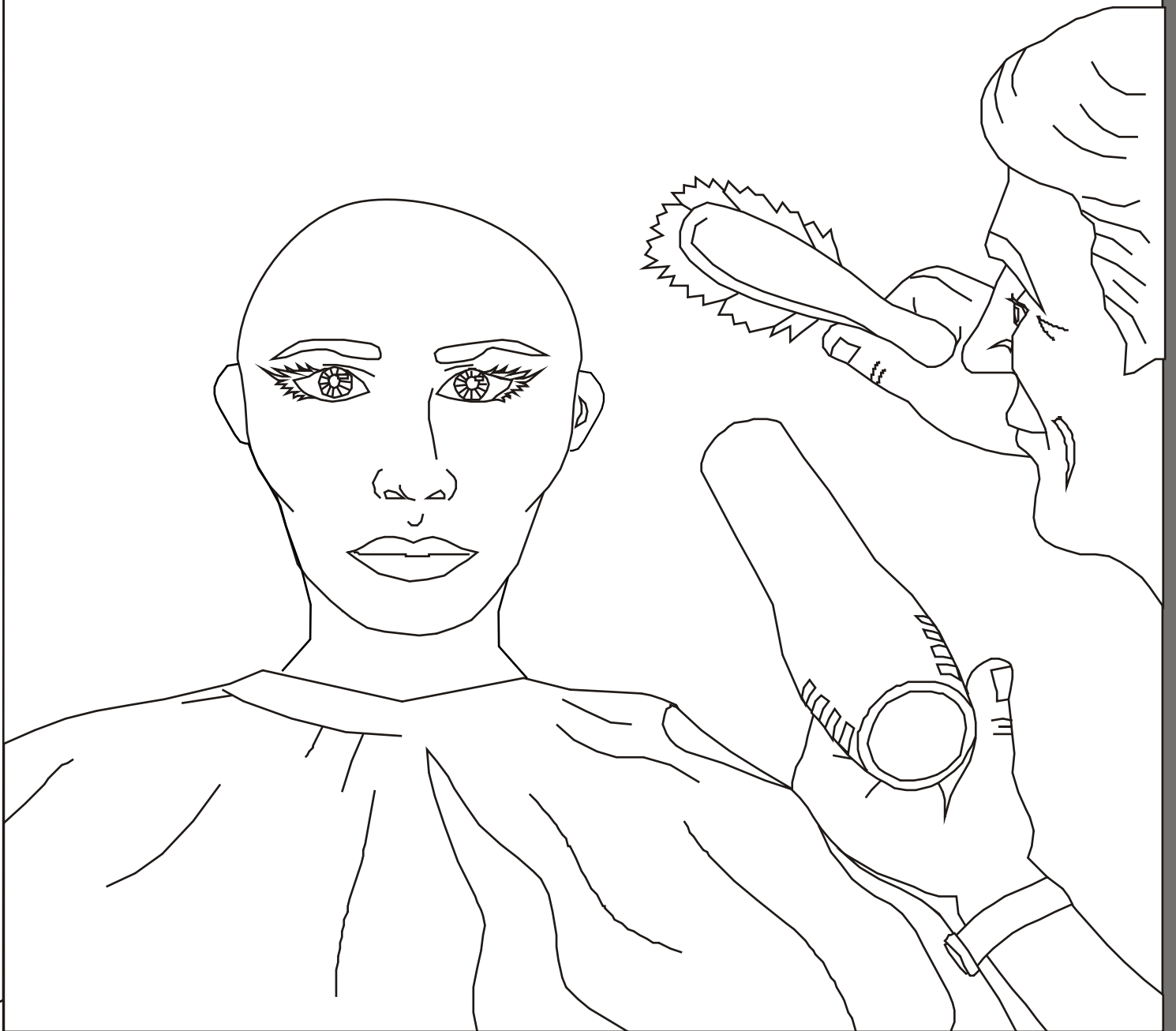

What's inside?

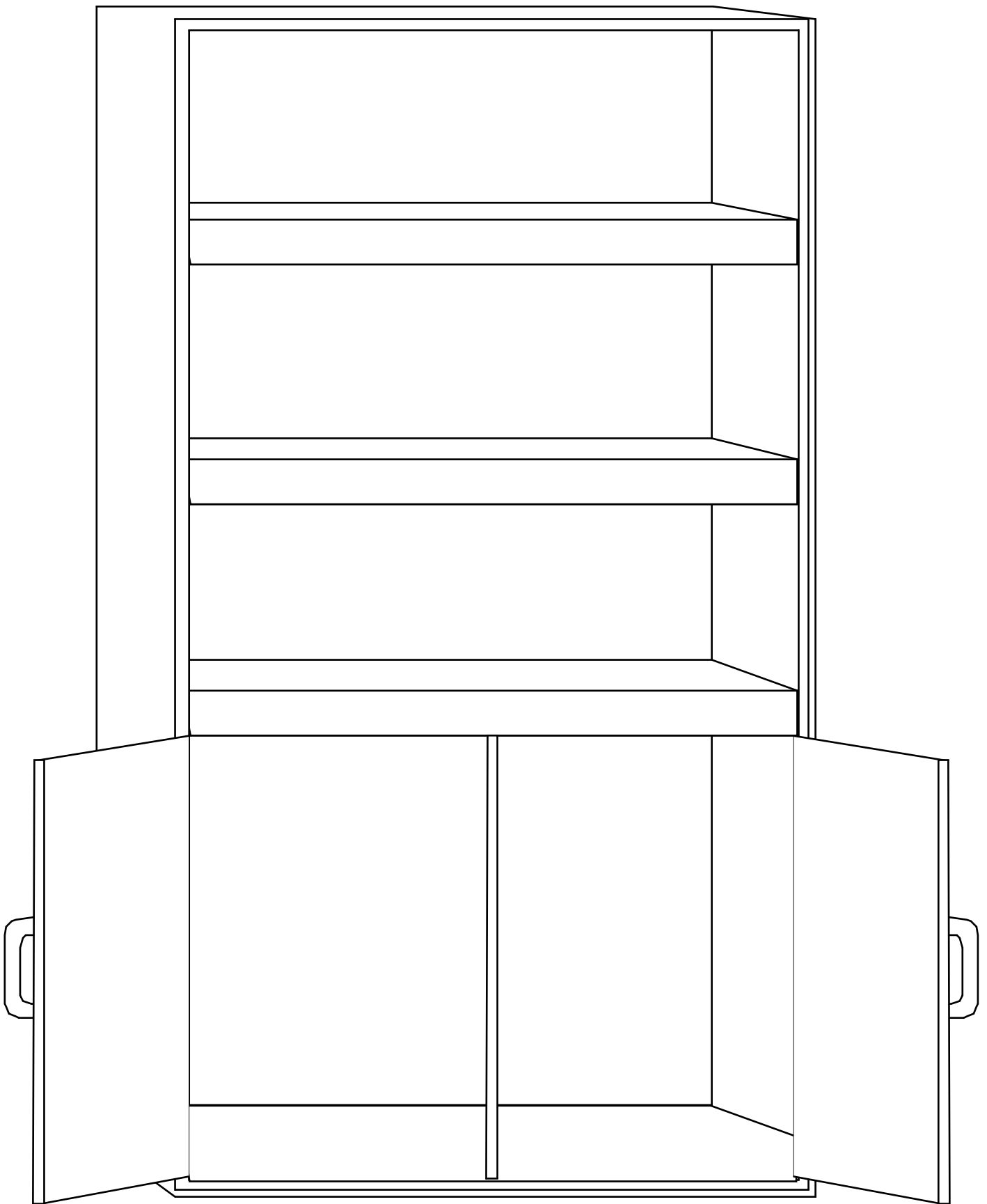

What's on the television?

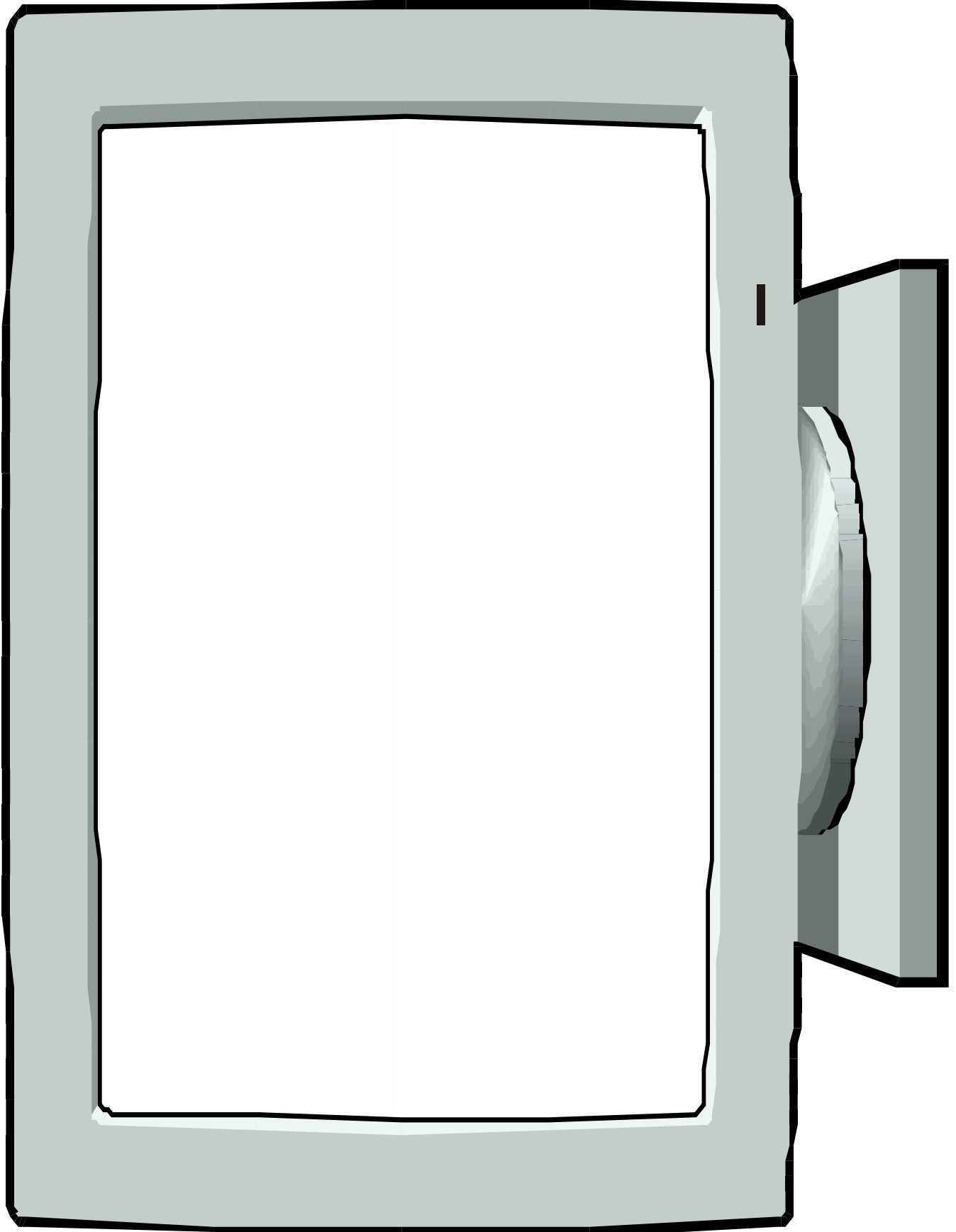

What's being made?

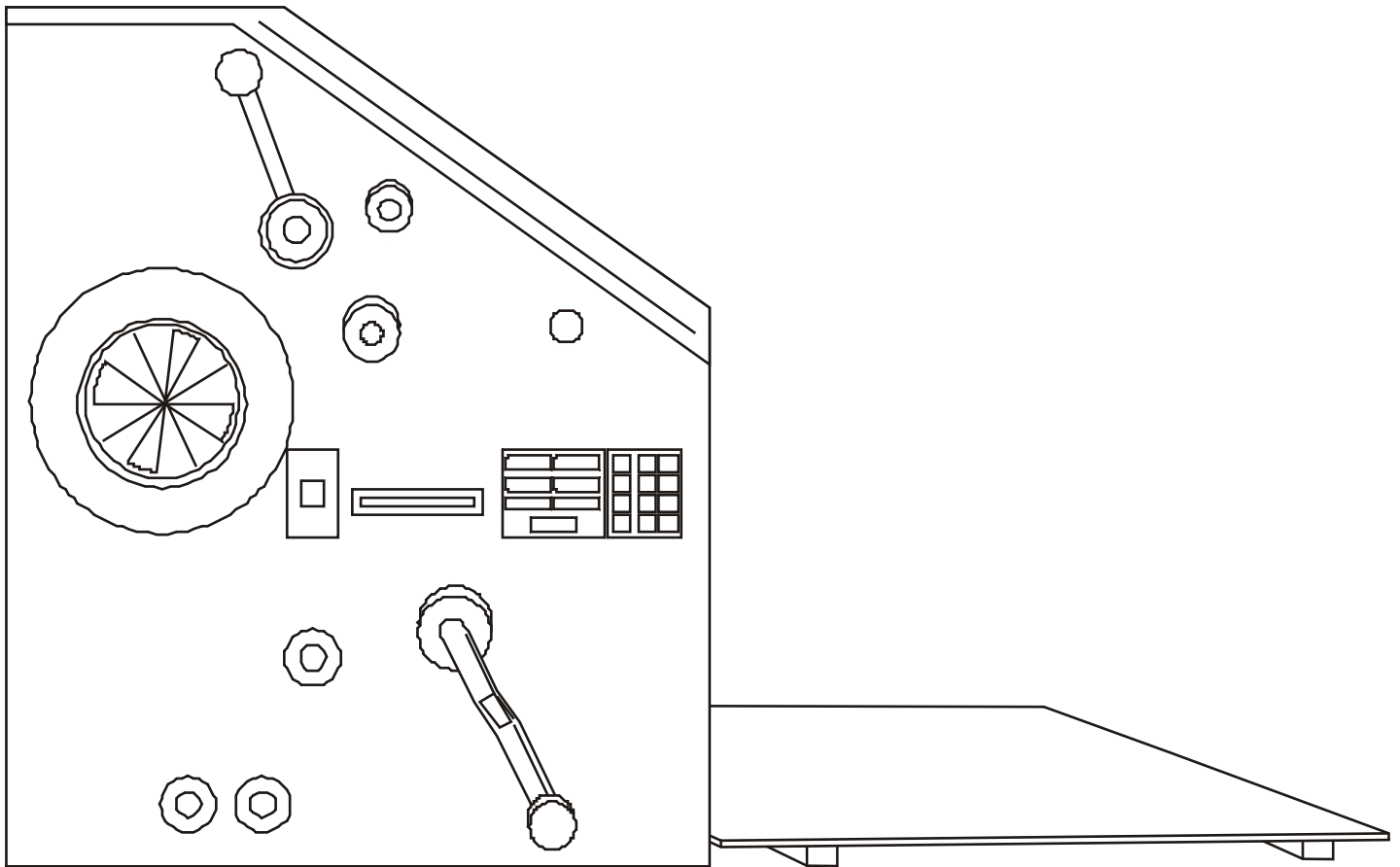

# Whose noses?



# Whose teeth?

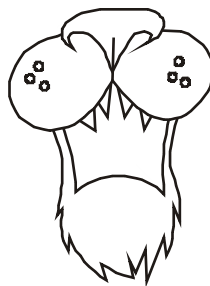
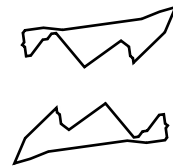
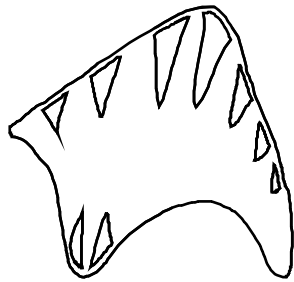

# Magnify the ants

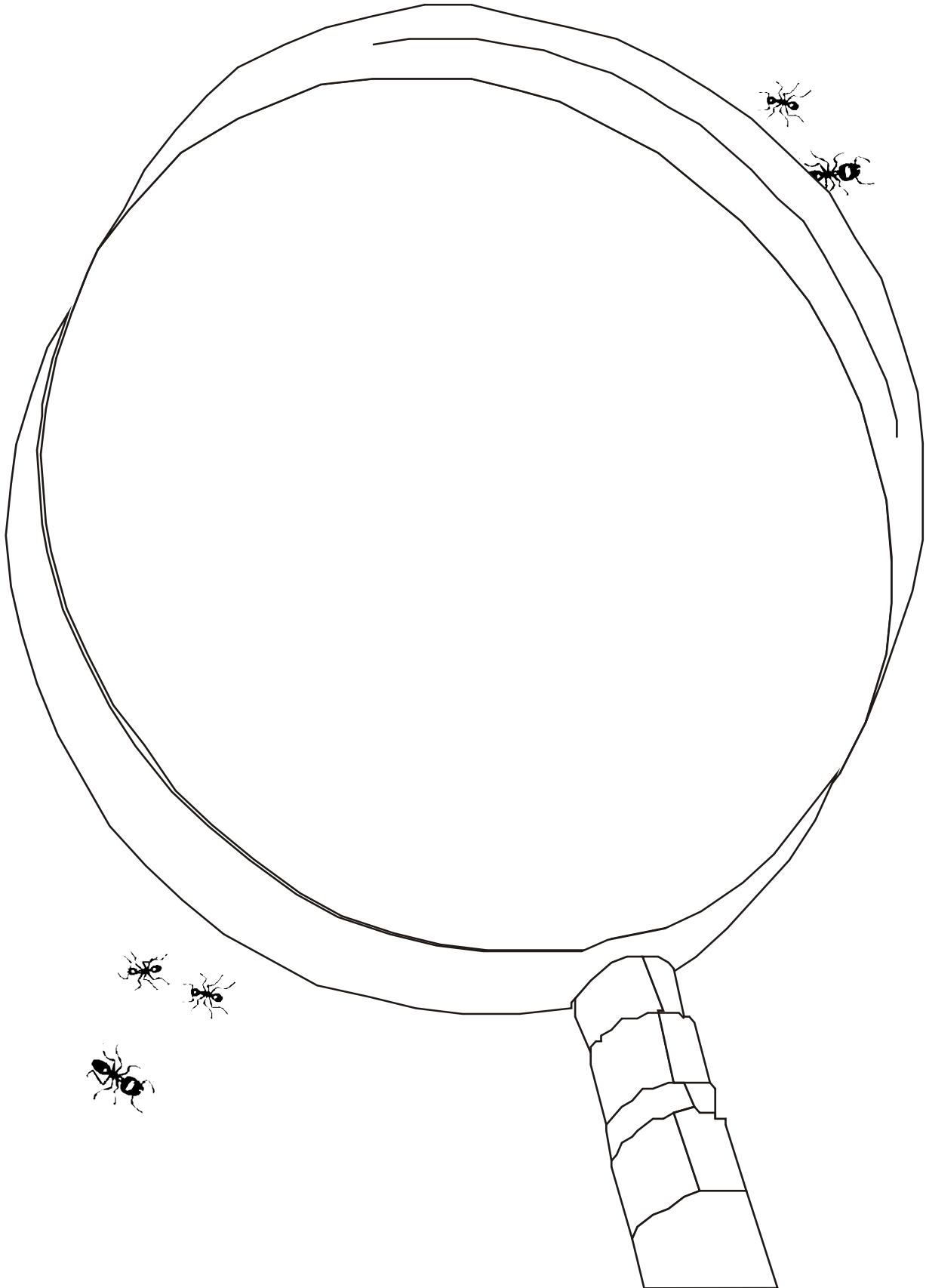

What's in the cave?

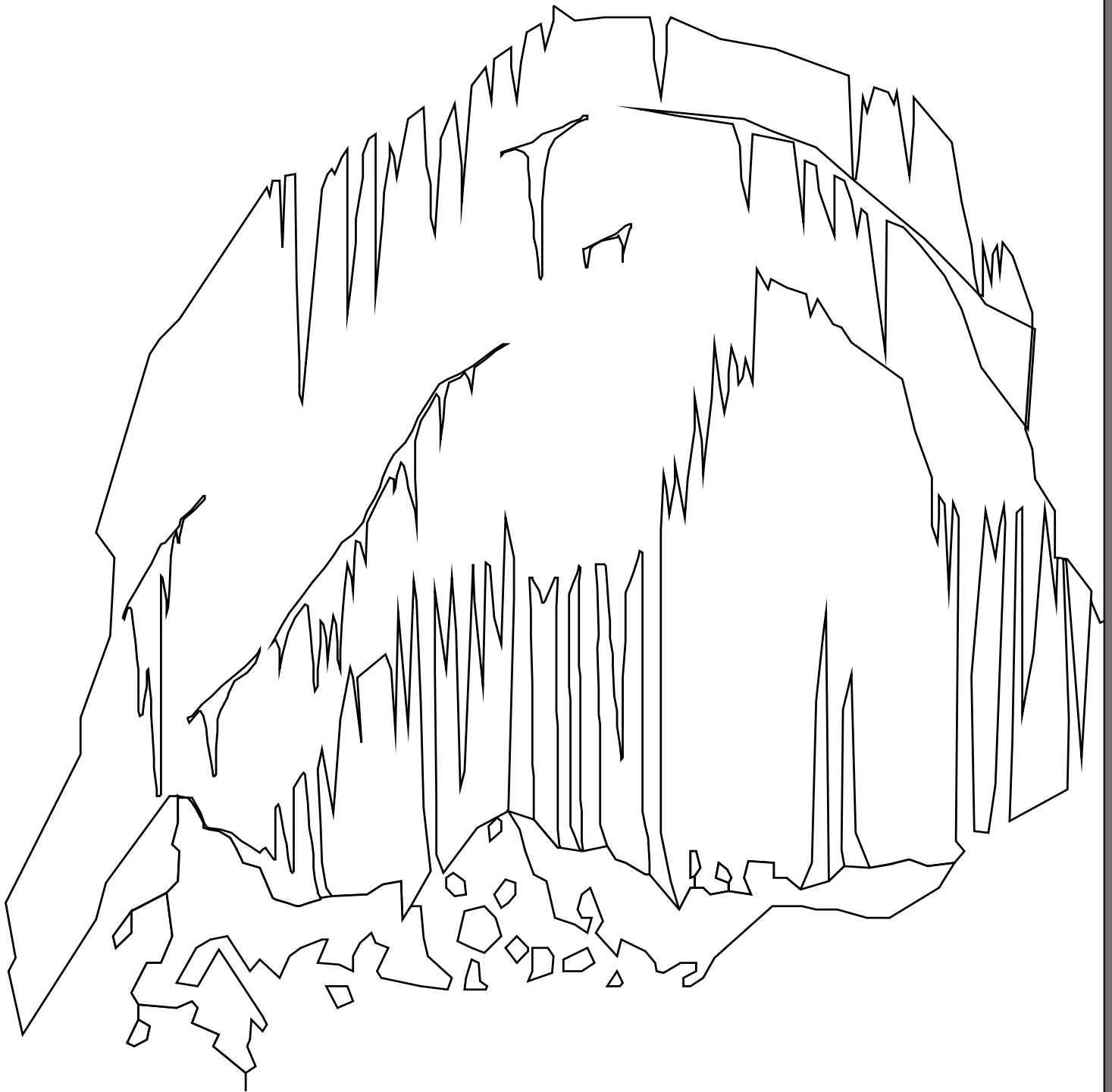



Any alligators in the swamp?



Show the reflection in the lake



What's behind me?



Give me some friends



Aliens have landed!

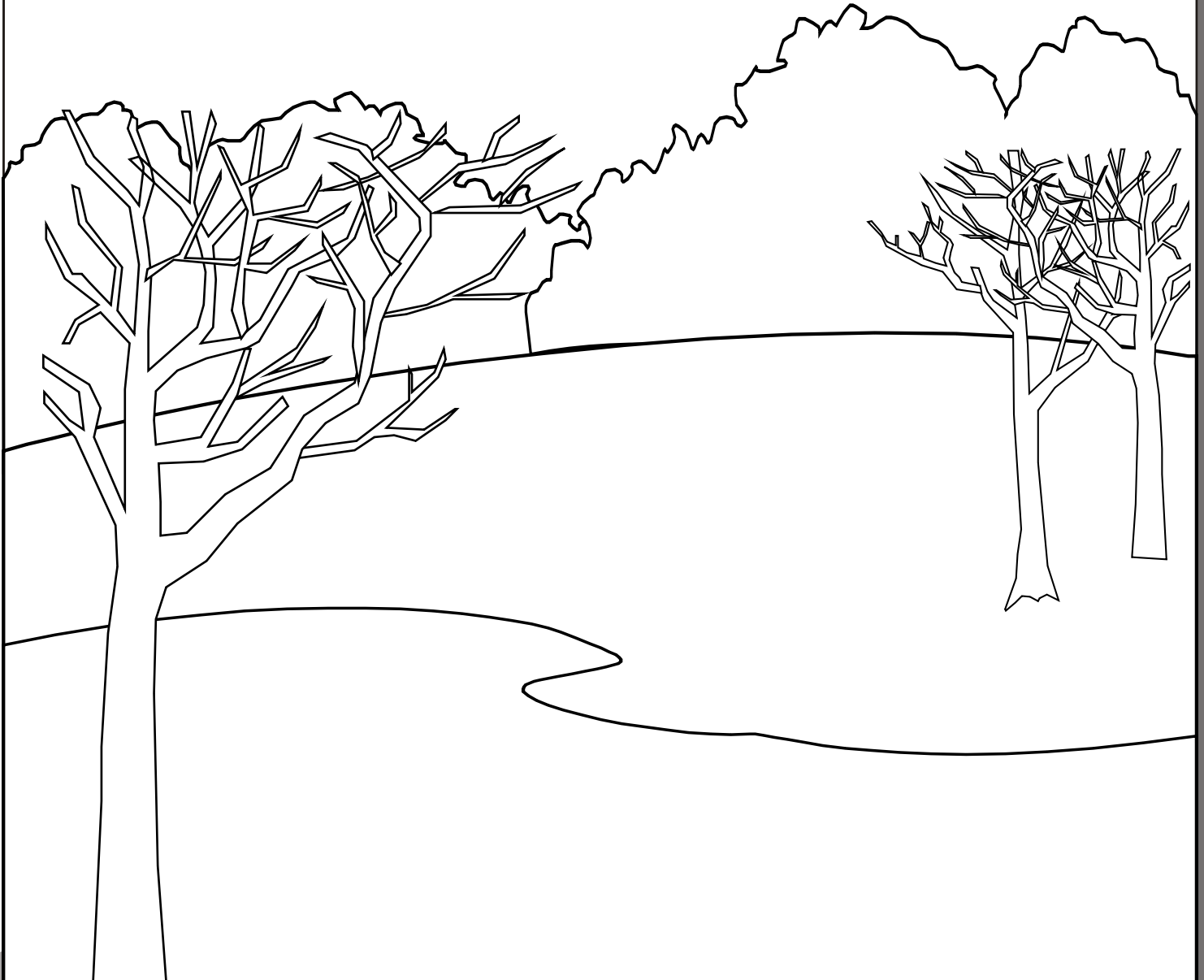
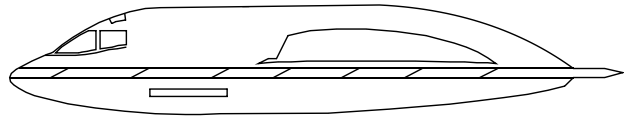

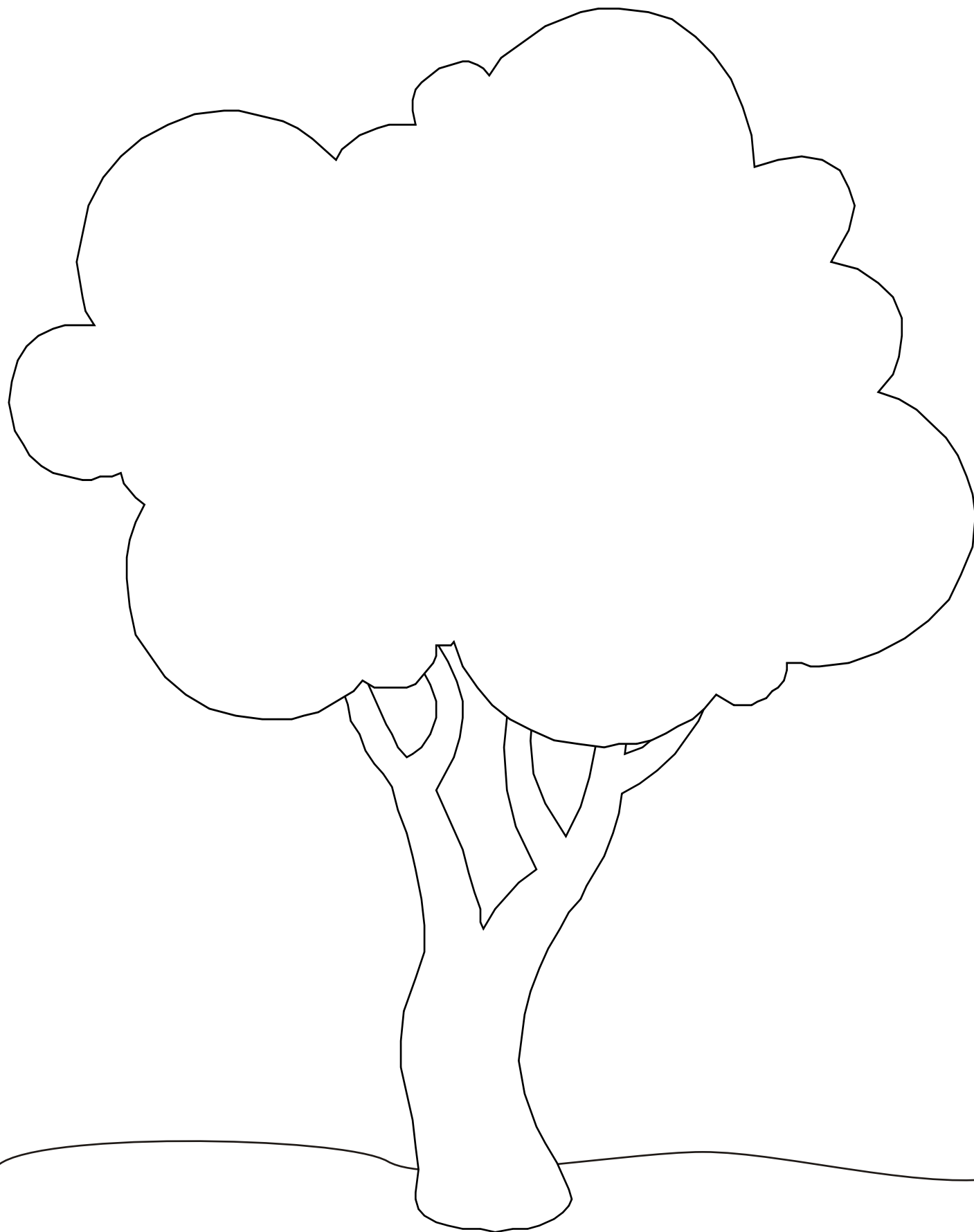

Finish building the city

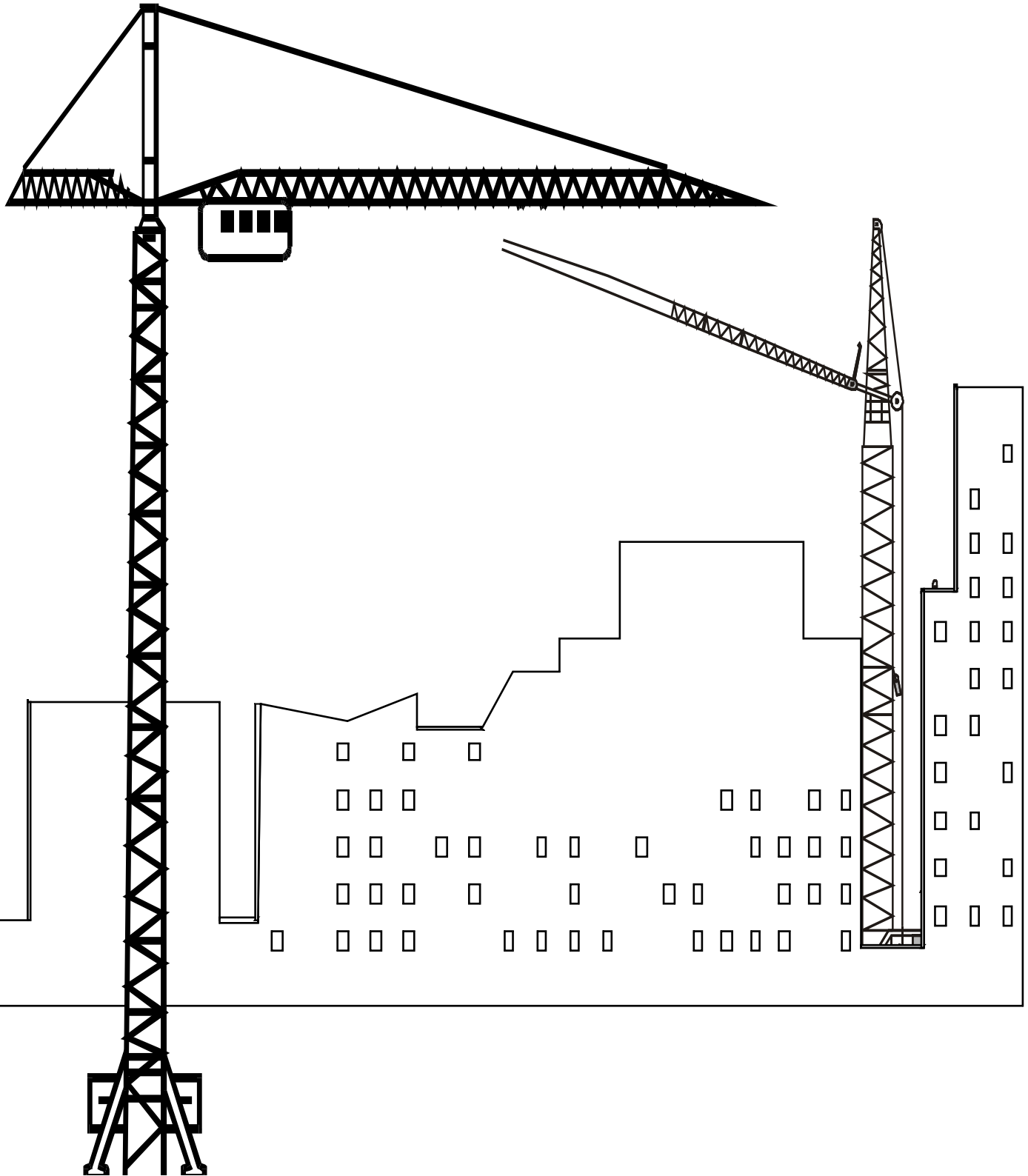

Decorate the fan

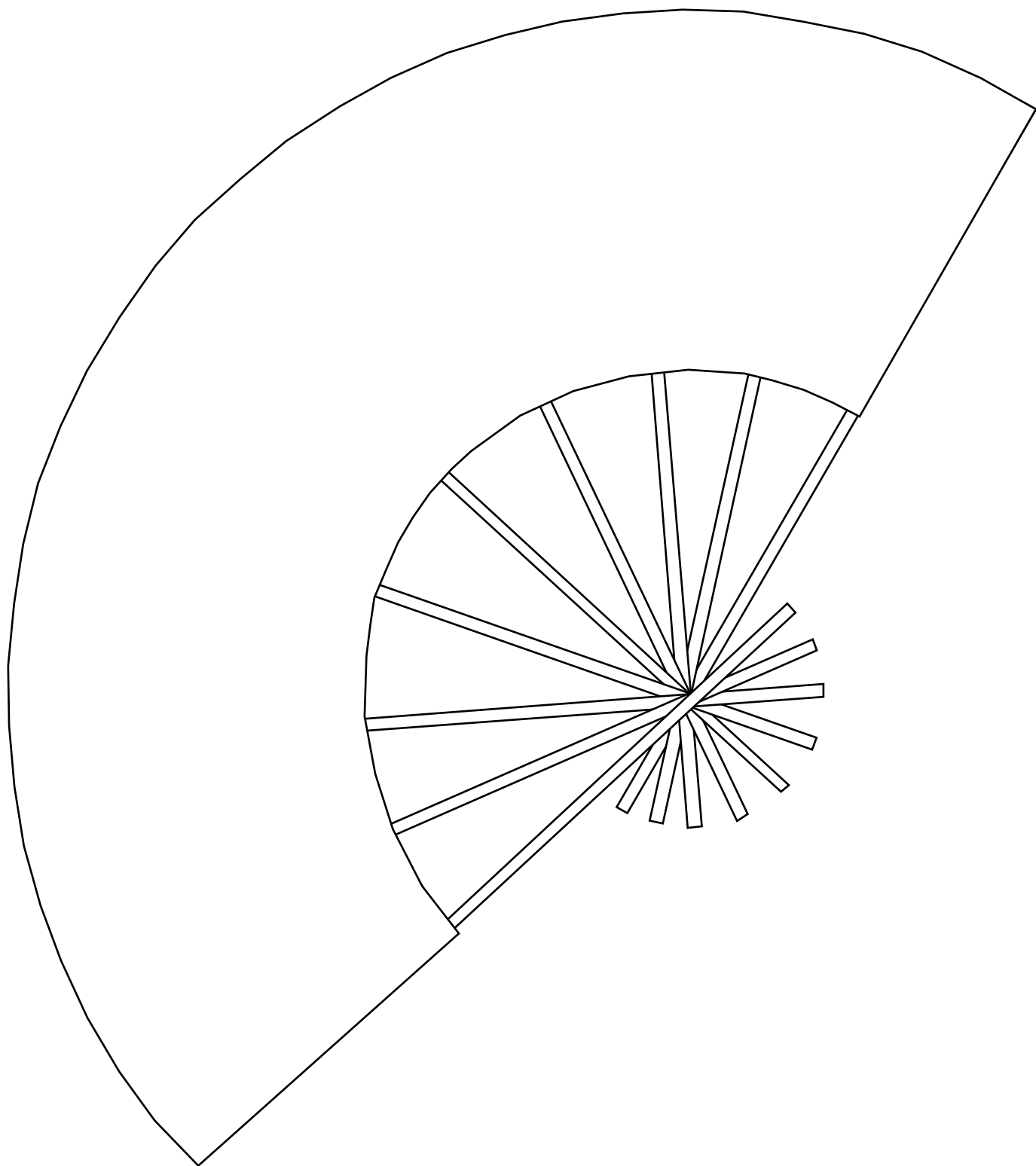



Decorate the tree



JUNTA DE ANDALUCÍA

Consejería de Educación  
CEIP Cristóbal Luque Onieva

Who's at the door?

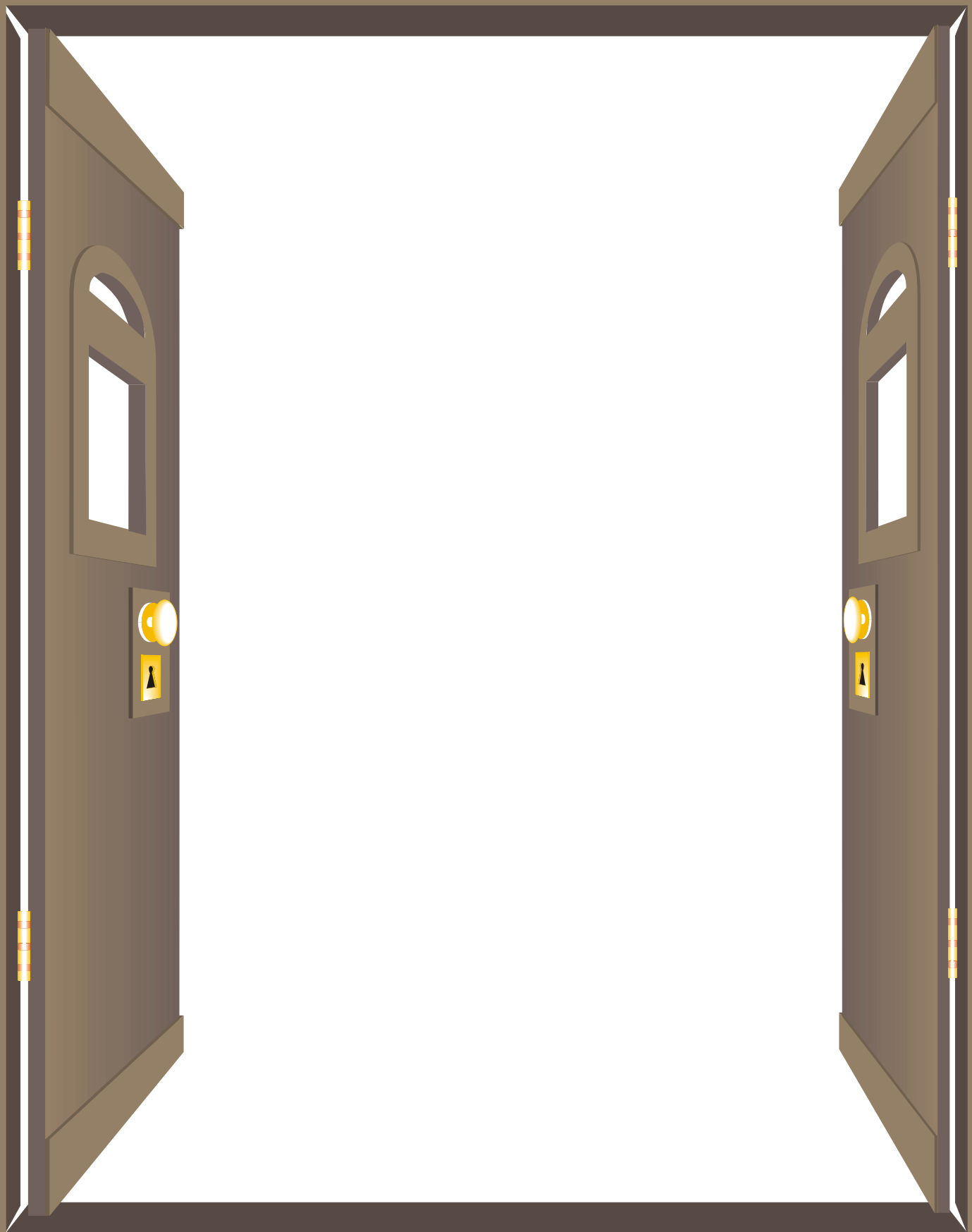

Área de Ed. Artística. Proyecto Bilingüe

CREATIVIDAD